

Profile kit

#	Image	Profile type	Length	Note	Qty
1		40x80L	195mm		2
2		40x80L	1350mm		2
3		40x80L	420mm		1
4		40x80L	500mm		3
5		40x80L	580mm		2
6		40x40L	500mm		2

Hardware kit

#	Image	Name	Note	QTY
7		Cilindrical socket head M6x16	Black, steel	10
8		Cilindrical socket head M6x20	Black, steel	12
9		Cilindrical socket head M8x16	Black, steel	12
10		Cilindrical socket head M8x20	Black, steel	4
11		NUT M6 DIN 985	Galvanised	12
12		NUT M8 DIN 985	Galvanised	4
13		GT1 evo wheeldeck [Alu 5mm]	Aluminium, 5mm	1
14		GT1 evo pivot plate LEFT [Alu 5mm]	Aluminium, 5mm	1
15		GT1 evo pivot plate RIGHT [Alu 5mm]	Aluminium, 5mm	1
16		GT1 evo pedal deck [Alu 5mm]	Aluminium, 5mm	1
17		Socket head bolt M6x20		4
18		Socket head bolt M8x16	DIN 912	60
19		Cover cap for Connection angle 36x36x38mm		28
20		Cover Cap 40 x 40		4
21		Cover Cap 40 x 80		9
22		Corner bracket 40x40		28
23		Rubber feet		4
24		Slot nut M6		20
25		Slot nut M8		80

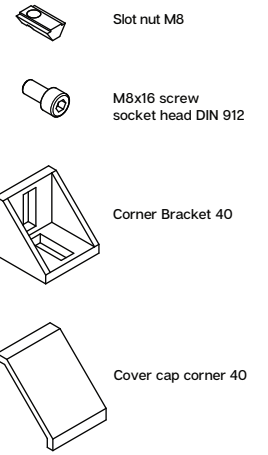
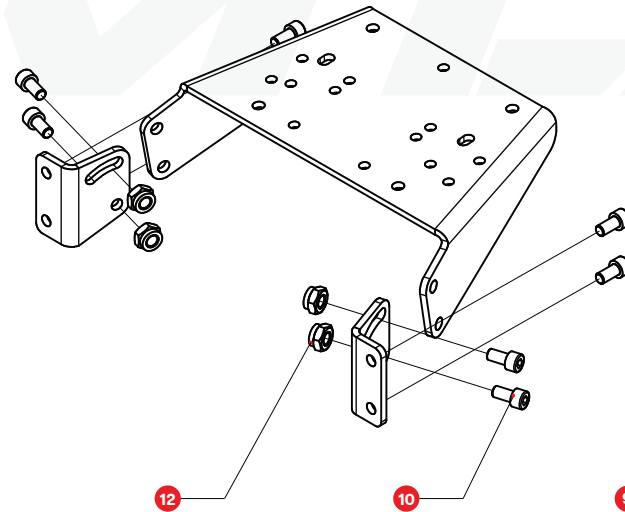
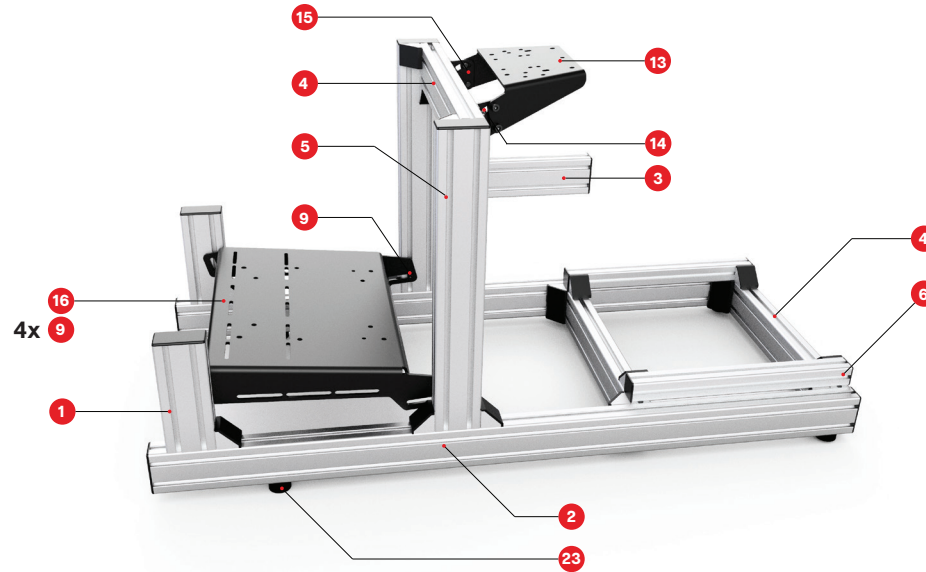

Connector bracket parts

Example

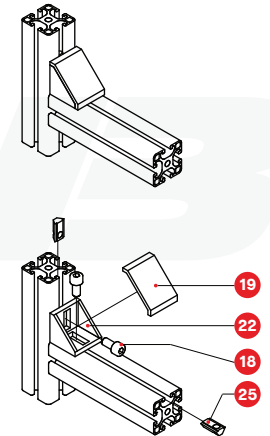

Connector bracket assembly

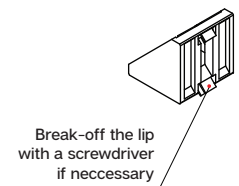

GT1 Evo - sim racing chassis revision 1.4